



E8 500 Swing Gate Opener Installation & User Manual EGA-04 Controller



Scan the QR Codes below for further assistance



Website
support page



Helpful
Videos

Table of Contents

Important Safety Information	3 - 5
Technical Specifications	6
Kit Inclusions	7 - 8
Optional Extras	9
Example Setup of Single Swing Gate	10
Example Setup of Double Swing Gates	11
Before You Begin (Power Options & Solar Panel)	12
Proper Gate Installation	13
Installation Pointers	14
Cardboard Template	15
Installation of Gate Opener	16
Pull or Push to open setup	17
Installing the Gate Stop	18
Manually Opening and Closing Gate	19
Pull-to-Open Setup	20 - 26
Installing Post Brackets	22 - 23
Installing Gate Bracket	24
Push-to-Open Setup	27 - 34
Installing Post Brackets	29 - 30
Installing Gate Bracket	31
Transformer info	34
Solar Panel info	35
Setting up your control board	36
Auto Travel Function (IMPORTANT).....	37 - 38
Remotes	39 - 40
Menu Settings	41 - 43
Control Board Specifications and Details	44 - 45
Other Considerations	46
Troubleshooting	47
Usage Problems	48
Attaching Control Box Lid	48
Other Information	49
Routine Maintenance	50

WARNING

Important Safety Information

Gate equipment has hazards associated with its use and therefore by installing this product the installer and user accept full responsibility for following and noting the installation and safety instructions. Failure to follow installation and safety instructions can result in hazards developing due to improper assembly.

READ ALL INSTRUCTIONS CAREFULLY AND COMPLETELY before attempting to install and use this automatic gate operator. This gate operator produces a high level of force. Stay clear of the unit while it is operating and exercise caution at all times.

All safety instructions should be read and completely understood by installer and the owner prior to the installation of the E8 auto gate system. This product is designed and manufactured for the use indicated in the manual.

Remember that all automatic gates are intended for vehicular gates only. A separate gate or entrance must be installed for pedestrian use. Any other use, not expressly indicated may damage the product or be a source of danger.

Swing Gate Motor - Model E8

E8 swing gate motor is suitable for light - medium opened framed gates, eg farm gates or pool fencing style etc. Do not use it on large sized gates which exceed the maximum recommended gate weight and length nor on gates with rising hinges or self closing hinges. Wrong selection of motor will result in an unreliable operation and void your warranty..

Please Read This First!

Thank you for purchasing the E8 “do-it-yourself” automatic gate opener! When correctly installed and properly used, your E8 Gate Opener will give you many years of reliable service.

The E8 Opener is designed for installation on a pull-to-open or push-to-open gate.
The E8 Gate Opener can be used on aluminum, chain link, farm tube, and wrought iron gates.

Use on solid surface gates is NOT recommended. Solid surface gates have a high resistance to the wind. If the wind is strong enough, the operator will obstruct and stop.

The E8 Gate Opener accommodates extra transmitters, digital keypads, solar panels, push buttons, automatic gate locks, and other access control products.

The E8 Gate Opener features an obstruction sensor. This feature makes the gate stop and reverse open when it comes in contact with an obstruction. This sensitivity can be adjusted on the main control board.

The E8 Gate Opener has an adjustable auto-close feature. After the gate reaches the fully open position, it can be set to remain open up to 99 seconds before automatically closing. Pressing the transmitter button at any time after the gate opens fully will cause it to close immediately. OFF is the factory setting; meaning the gate will stay open until you press the transmitter (or keypad, etc.) again. You can adjust this in the menu settings.

Important Safety Information

Because automatic gate operators produce high levels of force, consumers need to know the potential hazards associated with improperly designed, installed, and maintained automated gate opener systems. Keep in mind that the gate opener is just one component of the total gate operating system. Each component must work in unison to provide the end user with convenience, security, and safety.

This manual contains various safety precautions and warnings for the installer end user. Because there are many possible applications of the gate operator, the safety precautions and warnings contained in this manual cannot be completely exhaustive in nature. It does, however, provide an overview of the safe design, installation, and use of this product.

CAREFULLY READ AND FOLLOW ALL SAFETY PRECAUTIONS, WARNINGS AND INSTALLATION INSTRUCTIONS TO ENSURE THE SAFE SYSTEM DESIGN, INSTALLATION AND USE OF THIS PRODUCT.

Because the E8 automatic gate opener is only part of the total gate operating system, it is the responsibility of the installer and end user to ensure that the total system is safe for its intended use.

For the Installer and End User

After Installation

1. Attach the warning sign (included) to the gate to alert the public of automatic gate operation.
2. The gate is automatic and could move at any time, posing serious risk of entrapment. No one should be in contact with the gate when it is moving or stationary.
3. Do not attempt to drive into the gate area while the gate is moving; wait until the gate comes to a complete stop.
4. Do not attempt to "race the gate" while the gate is closing. This is extremely dangerous.
5. Do not allow children or pets near your gate. Never let children operate or play with gate controls. Keep the remote control away from children and unauthorized users; store controls where children and unauthorized users do not have access to them.
6. **KEEP GATE SYSTEMS MAINTAINED.** Always disconnect any power source from the operator before performing any maintenance.
7. To operate this equipment safely, **YOU** must know how to disconnect the operator for manual gate operation.
8. Disconnect the operator **ONLY** when all power sources are **DISCONNECTED** and the gate is **NOT** moving.
9. Make arrangements with local fire and law enforcement for emergency access.
10. Distribute and discuss copies of the **IMPORTANT SAFETY INFORMATION** section of this manual with all persons authorized to use your gate.
11. **IMPORTANT:** Save these safety instructions. Make sure everyone who is using or will be around the gate and gate operator are aware of the dangers associated with automated gate systems. In the event you sell the property with the gate operator or sell the gate operator, provide a copy of these safety instructions to the new owner.

Important Safety Information

WARNING

To reduce the risk of injury or death:

1. READ AND FOLLOW ALL INSTRUCTIONS.
2. Never let children operate or play with gate controls. Keep the remote control away from children.
3. Always keep people and objects away from the gate. NO ONE SHOULD CROSS THE PATH OF THE MOVING GATE.
4. Test the gate operator monthly.
5. Use the manual/emergency release only when the gate is not moving.
6. KEEP GATES PROPERLY MAINTAINED.
7. The entrance is for vehicles only. Pedestrians must use separate entrance.
8. The gate must be installed in a location that provides adequate clearance between it and adjacent structures when opening and closing to reduce the risk of entrapment. Swinging gates must not open into public access areas.

Owner should observe the following:

1. Do not cross the gate while it is operating.
2. Keep children away from the gate and the remote controls.
3. Test the system frequently and monitor the high and low speed of the system.
4. Practice the use of the emergency release key. This is crucial in the event that the system does not work.
5. Place the WARNING signs prominently on the gate to warn pedestrian of the automatic gate operation on your premises. It is your responsibility to post the warning signs on both sides of the gate.

Installer should observe the following:

1. Make sure the gate weight and length does not exceed the maximum specifications.
2. The gate design must be suitable for the installation of the auto gate system.
3. Ensure that the gate is installed on flat, level ground and can move freely in both directions along the entire swing of the gate. A properly balanced swinging type gate should NOT swing open or swing close when no pushing or pulling force is exerted onto it.
4. Control panel box must be installed in the area where it is not easily damaged.
5. Do not change with parts or components not supplied by manufacturer.
6. Make sure all wiring is correct and in accordance with electrical bylaws and in good condition before supplying the mains power to the control panel.
7. Remove all power when doing any maintenance including solar.
8. Ensure the control panel box is free from water leakage and insects to avoid short circuiting of the control panel. Silicon off any holes (moth balls may also help in the prevention of insects)
9. Never supply mains power directly to the DC motor
10. Transformer MUST be connected to mains power via RCD (residual current device).
11. Do not install the operating system if in doubt.

Technical Specifications

Supply voltage:	16vac Transformer or Solar 12v
Backup Battery:	12Vdc Lead acid maintenance free (Electric optional)
Operating Voltage:	DC 16-18V for normal speed DC 6-10V for cushioning speed
Driving Method:	Screw driven type
Max. Output Power:	80W per driver
Gear Box:	Three-stage spur gear reducer
Operating Cycle:	13-19 seconds Per 90° (on AC power only)
Max. Piston Stroke:	500mm
Max Piston Speed:	3cm/sec
Max. Weight of Gate:	250kgs (1.5mtr) dependant on gate length
Max. Length of Gate:	4.2m per leaf (500mm)
Safety Clutch:	Electronic current sensing, high amp cut off
Electronic Controller:	Micro-processor based
Remote Controller:	4 channel 433MHz

Kit Includes

Standard Packaging of the swing gate opener kit includes:

Single = 1 leaf Double = 2 leaves

Actuator Arm:	1 x for single or 2 x for double
Cardboard Template:	1 only
Primary Post Bracket:	1 x for single or 2 x for double
Secondary Post Bracket:	1 x for single or 2 x for double
Gate Bracket:	1 x for single or 2 x for double
Rubber Gate Stop:	1 only
Release Keys:	2 only
Primary Bracket Bolts:	Not supplied (Single x 4 or Double x 8)
Secondary Bracket Bolts:	2 x for single or 4 x for double
Gate Bracket Bolts:	2 x for single or 4 x for double
Rear Mounting Bolts:	1 x for single or 2 x for double
Release Bolts:	1 x for single or 2 x for double
Small Bracket set (3):	1 only
Control Box:	1 only
Main Control Board	
EGA-04:	1 only
Receiver:	onboard
Remotes/fobs:	2
12v Battery:	1 only (if solar)
Regulator:	1 only (if Solar)
45Watt Solar Panel:	1 only (if Solar) with 10mtrs cable + mounting bracket
Transformer 16VAC:	1 only (if Electric)
Conduit:	1 small piece only
Cable:	6m for double kits (across driveway for second actuator)
Junction box:	1 for double kit only

*you will be supplied with 1 or 2 slim flat plates that can be used for gate tabs if required

PLEASE NOTE:

POST BRACKET BOLTS AND CONTROL BOX MOUNTING BOLTS
ARE NOT SUPPLIED

STANDARD KIT INCLUSIONS



Warning Sign



Actuator Arm with cardboard template



Control Box



Remotes

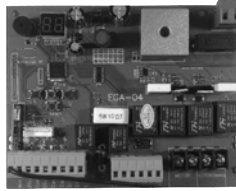

Main Control board

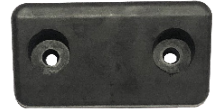

Rubber Stop



12v Battery (solar)



Regulator
(if Solar)



45watt Solar Panel
(if Solar)



Transformer
(if Electric)



Bracket Set
(3)



Release Key



Gate Bracket



Primary
Bracket



Secondary
Bracket



Gate Bracket
Bolts



Release Bolt



Mounting Bolt



P & S Bracket
Bolts

OPTIONAL EXTRAS



Round Gate Bracket



Round Post Brackets



Adjustable Hinge



Push to open Bracket

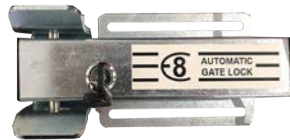

Electric Gate Lock



Adjustable Hinge



Long Range Receiver



Wireless Keypad



Wired Keypad



Warning Light



Wired Eyeballs



Push Button



Keyed Push Button
(wireless or wired available)

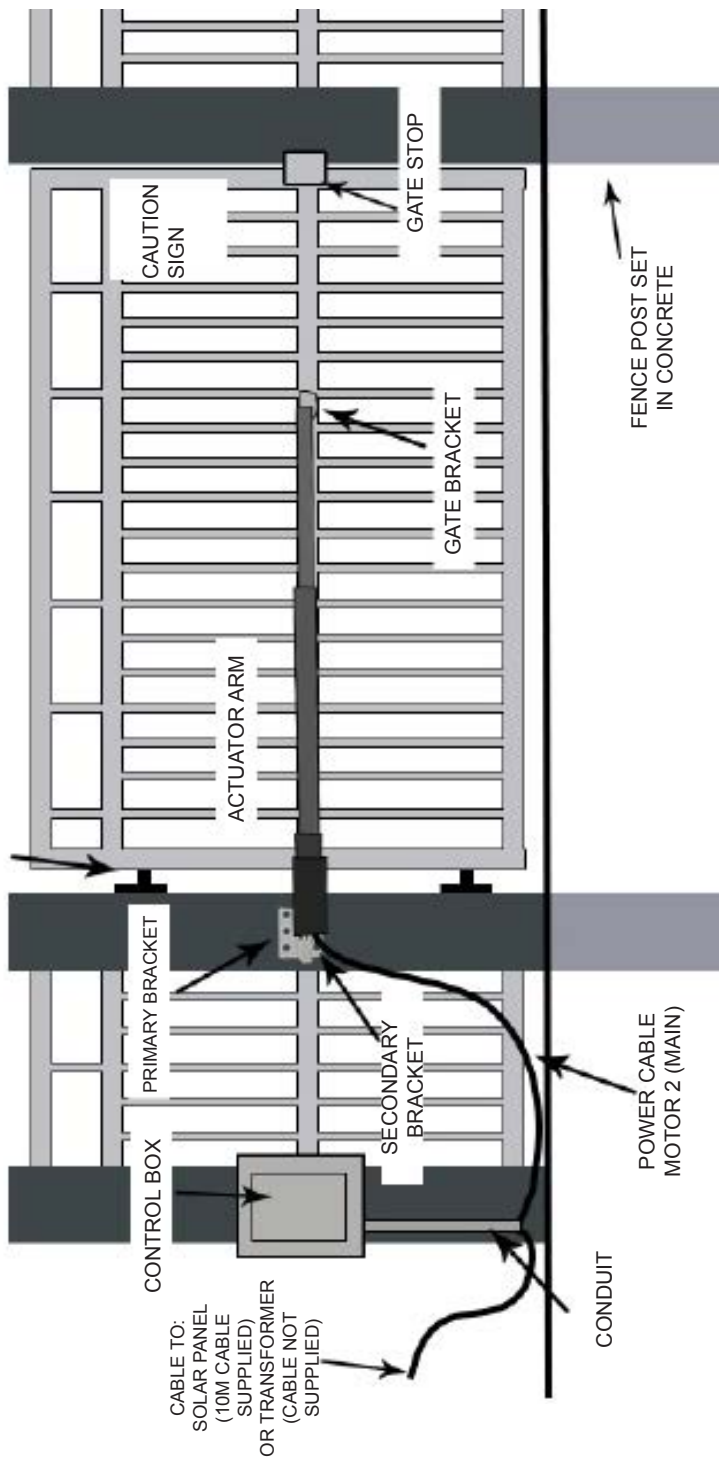

Single Swing Setup Example

Installations vary slightly on different types of gates

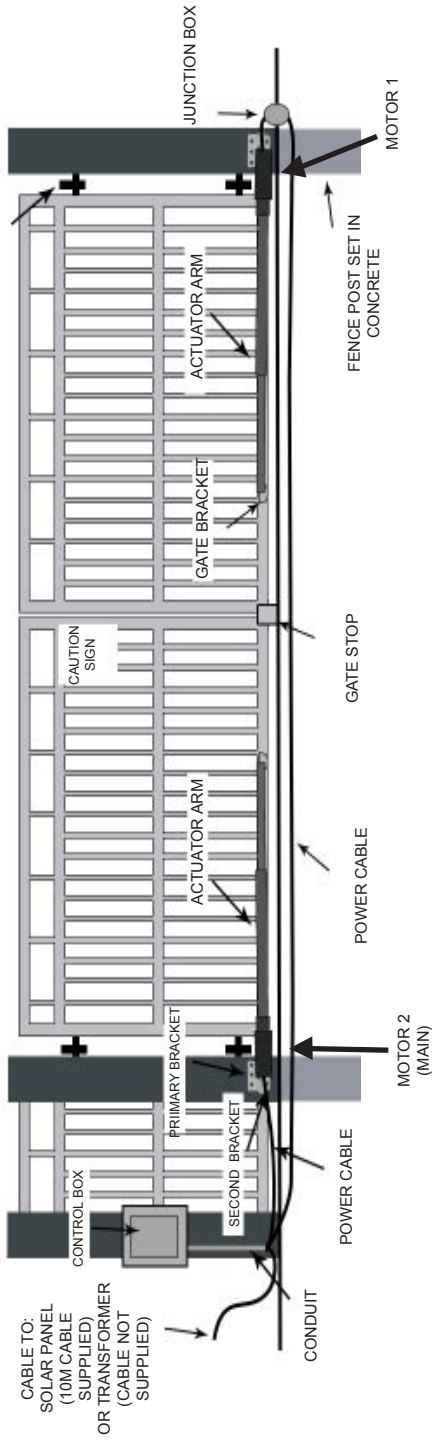

Double Swing Setup Example

Installations vary slightly on different types of gates

Before You Begin

POWER OPTIONS

1. Determine Charging Option for Battery: Transformer OR Solar

NEVER USE TRANSFORMER AND SOLAR PANEL(S) AT THE SAME TIME.
It will damage the control board.

IMPORTANT

- Transformer is suitable for outdoor use. Use 2.5m x 2 core cable
- The gate opener is designed and intended for use with a 12 Volt sealed lead acid battery.

SOLAR PANEL

The solar panel should face full NORTH with a minimum of 6 hours of DIRECT sun exposure to be effective (filtered sunlight not acceptable). The solar regulator supplied is not weatherproof and must be located in the main control box to protect it.

The performance of your gate opener is dependent on your geographical location, weather conditions and seasonal lighting availability. On cloudy days and during winter, your solar panel will not receive as much direct sunlight, resulting in reduced output and may reduce operating time. Accessories connected to your system will draw additional power from the battery. It is recommended to not use more than 1 hard wired device, such as keypad, gsm, safety beams etc. For maximum charge see below for your area and recommended tilt:

Brisbane 38°
Sydney 45°
Melbourne 50°
Tasmania 56°
Adelaide 48°
Darwin 14°
Perth 43°
0° being flat and 90° vertical



Important: just one hand print of shade on your solar panel can reduce your solar panels output by up to 80%.

INCORRECT



Solar panel should be installed with junction box at the top

CORRECT



IMPORTANT: Check For Proper Gate Installation

- The gate must be plumb, level, and swing freely on its hinges.
- The gate must move throughout its arc without binding or dragging on the ground.
- A properly leveled/plumbed gate will not have the tendency to self-open or self-close and remain stationary. A self-opening or closing gate suggests that the gate is not level/plumb. This will cause accelerated wear to your automatic gate system.
- Wheels must NOT be attached to the gate.
- Post must be secured in the ground with concrete (minimizes twist/flex when the operator is activated).
- Make sure there is a stable area for mounting the gate bracket.
- We recommend you position the operator near the centre-line of the gate to keep the gate from twisting and flexing, and to avoid back-splash from rain.
- Double gates - rubber gate stop supplied will need to be bolted down to the middle of the driveway for the gates to close up onto
- Single gate - gate will either close up onto the opposite post or you can install the rubber gate stop on the post for the gate to strike
- You can install another gate stopper at the full open position or you may choose to let the gate swing till it is stopped by the internal built in stop mechanism when the arm is fully retracted (pull to open position) or fully extended (push to open position).
- Installing a gate stop at the full open position will allow for a firm/solid push and prevent the gate from swaying or moving in moderately windy conditions.

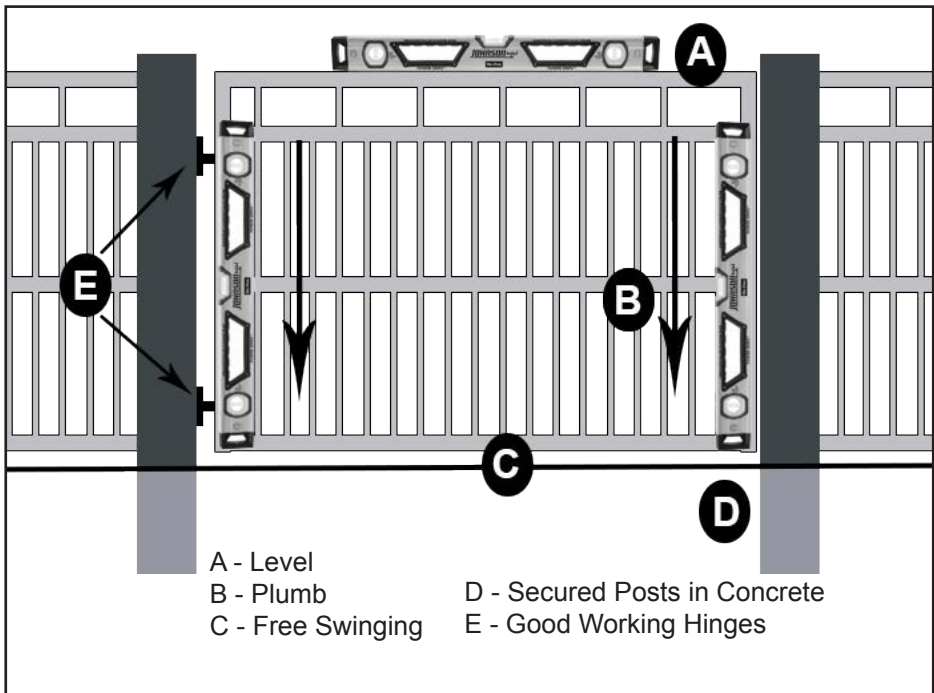

Installation Pointers

The proper position of the Primary and Secondary Brackets (post bracket) and gate bracket is crucial to the efficiency and leverage of the gate opener. Attention needs to be paid to both its correct height and its position on the post in respect to the relationship between your gate hinge pivot point and the motor pivot point on the bracket. Once you have determined the general desired height of the actuator arm, position the bracket and take note of the dimensions.

Its best to locate the gate opener arms in approximately the middle between the top and bottom of the gate. This will prevent the gate from twisting or flexing and provide a more even pull and push over the entire gate.

Pull-to-Open and Push-to-Open (Terminology) see page 17

- For pull-to-open gate - Arm is fully retracted when the gate is fully opened (gate pulls inwards)
- For push-to-open gate - Arm is fully extended when the gate is fully opened (gate pushes outwards)

Mounting of the Control Box

Select a flat and sturdy surface for the mounting of the control box.

Care must be taken to ensure that the mounting screws and holes on the control panel are properly sealed to prevent water seepage and insects into the control box (silicon around screws). All cabling must go through the entry hole located at the bottom of the control box.

Water damage or insect damage to the control board will void your warranty.

The mounting point guides located in your control box serves only as reference and a guide for your installation. We recommend that the mounting points be lower than the control board, so that in the unlikely event that water seeps in, it will not flow onto the control board.

Cardboard Actuator Template

The cardboard template is a guide for the actuator arm in Full-Open and Full-Close positions. The template is simply 2 x card board strips with a screw joining the 2 together. The screw is acting as your pivot point where the actuator arm will attach to the secondary bracket.

This is an easy way to determine the best position to drill your bracket mounting points for your post and gate brackets and take the guess work out of installation.

Clamping your brackets first is always recommended.

You may need to change the bracket or design a new one that best suits your application.

Each arm guide has a mark measured from the screw.

The screw represents the position of the secondary post bracket pivot.

The outer lines marked on the guide represents the position of the gate bracket pivot.

Short template – Arm fully retracted

Long template – Arm fully extended

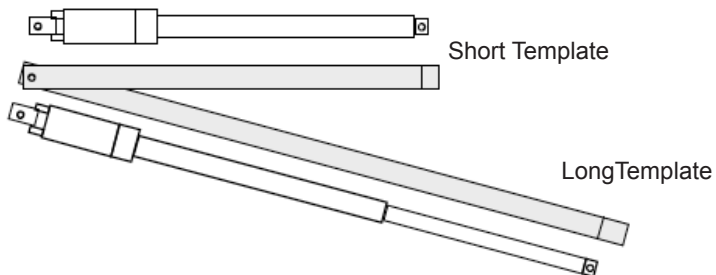

Installation of Gate Opener

Primary and Secondary Post Brackets

The position of the Primary and Secondary post brackets are crucial to the success of your installation and attention needs to be paid to both correct height and position on the post in respect to the relationship between your hinge pivot point and the motor pivot point on the bracket. Once you have determined the general desired height of the actuator arm, position the bracket and take note of the dimensions.

In a standard installation the basic aim is to get the “J” and “K” dimensions to be as close as possible to equal.

Hint: The dimension of BOTH J and K for a standard installation is approximately

For 500mm Arm

J ~ 250 mm

K ~ 250 mm

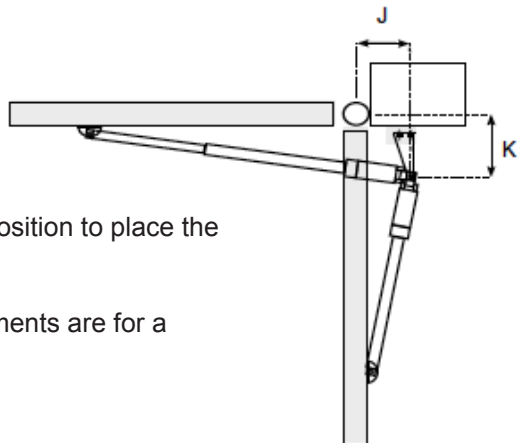

This dimension is a good initial position to place the cardboard template.

Please note the above measurements are for a guide only.

How to determine if I have a pull or push to open setup

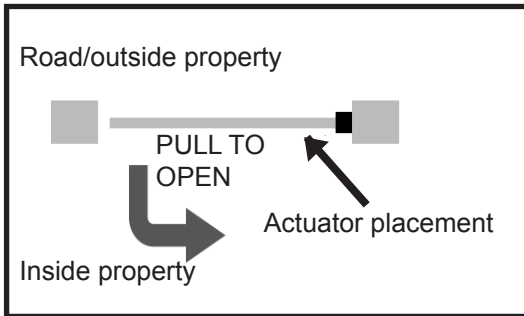

Pull to open setup A

Actuator arm mounted on the inside of the property pulling the gate into the property to open. Go to page 20 for setup

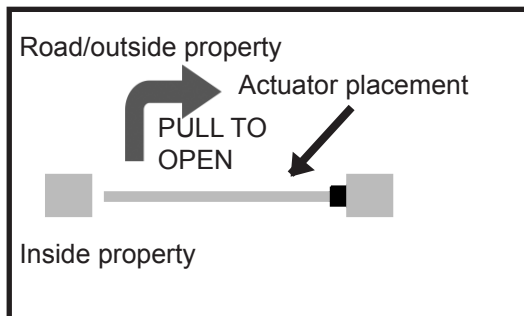

Pull to open setup B

Actuator arm mounted on the outside of the property pulling the gate outwards to open. Go to page 20 for setup

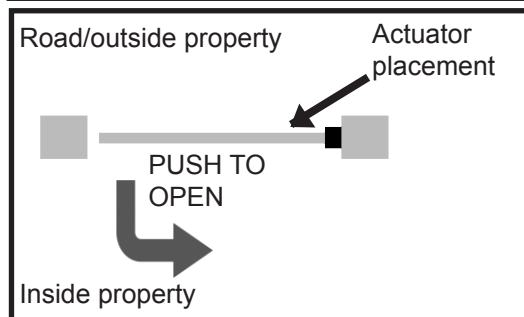

Push to open setup A

Actuator arm mounted on the outside of the property pushing the gate inwards to open. Go to page 26 for setup

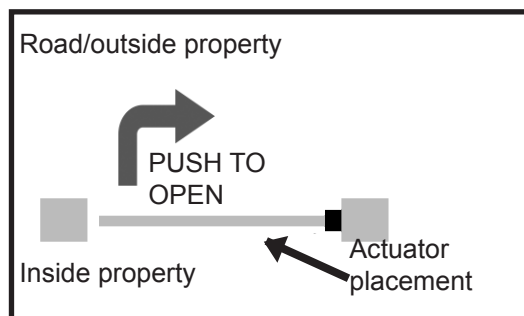

Push to open setup B

Actuator arm mounted on the inside of the property pushing the gate out towards the road to open. Go to page 26 for setup

Installing the Gate Stop

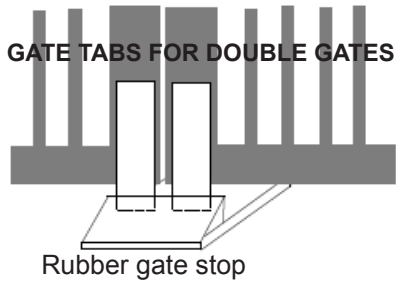

Double Gates

Installing the rubber gate stop is required to ensure proper alignment of the two gates and for them to have a solid push onto the stopper in the fully-closed position.

Note: you will be supplied with 2 metal tabs in a double kit which can be used if your gates don't hit the stop due to the gap between the gates and rubber stop.

Single Gates

The gate should either stop onto a post in the closed position, or you can use the rubber gate stop and place it onto the post allowing the gate to have a solid push in the closed position. If using the rubber stop, make sure you place it on the same level as the actuator arm to avoid



Full-Close Position

Each gate must stop on a firm and well secured Gate Stop in the closed position. Failure to do so may result in misalignment and accelerated wear to the system and the gate hinges.

Full-Open Position

In the full-open position, the gates can either be hard stopped by a peg / stopper, or be stopped by the internal built-in mechanism at the end of the retracted arm (Pull-to-Open gate) or fully extended arm (Push-to-Open gate).

Manually Opening and Closing Gate

CAUTION

The gate will move freely and uncontrolled when the gate operator is removed from the gate. ONLY disconnect the operator when the power source has been disabled
(ie. battery or transformer is off and the gate is NOT moving)

Disconnecting the Opener

1. Place the release allen key into the release bolt and unscrew fully
2. Pull actuator arm off gate bracket
3. Now the gate will swing freely

If leaving the actuator arm off the gate please disconnect power to avoid damaging the motor or cable.

The gate can be opened and closed manually when the actuator is disconnected.

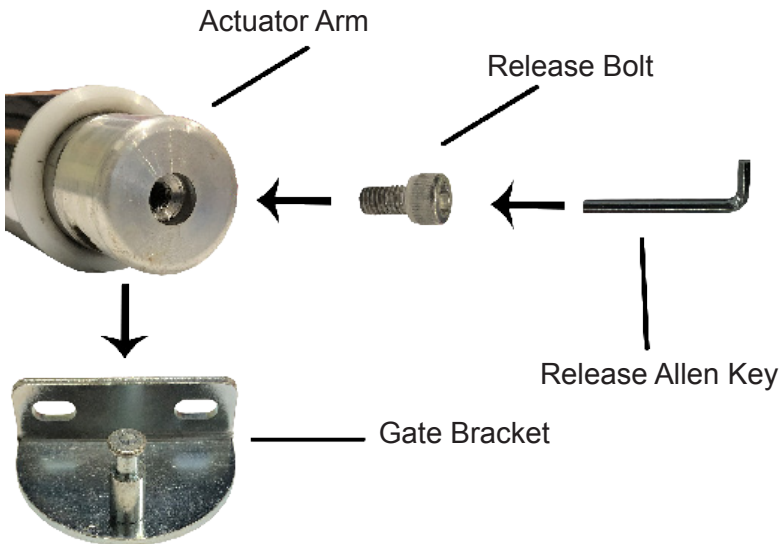

If you need to remove the arm from the gate you must keep it in a horizontal position at all times. Placing the arm in a vertical position for a period of time may cause water to seep into the motor housing and eventually damage the motor. This will void your warranty.

Pull-to-Open Setup

Pull-to-Open Setup - TEMPLATE

You will be supplied with a cardboard template in your kit. The long section of the template represents the actuator arm at full extension and the short section of the template represents the actuator arm retracted. The lines on the end of the template represents the gate bracket pin.

If you require full extension and full retraction of your actuator arm (this will provide minimum force on the gate and hinges) you can work your pivot point out using the 250mm x 250mm J and K measurement noted in the image to the right (or see pg 16) . Otherwise if this is not required you will roughly work out your pivot in the next steps.

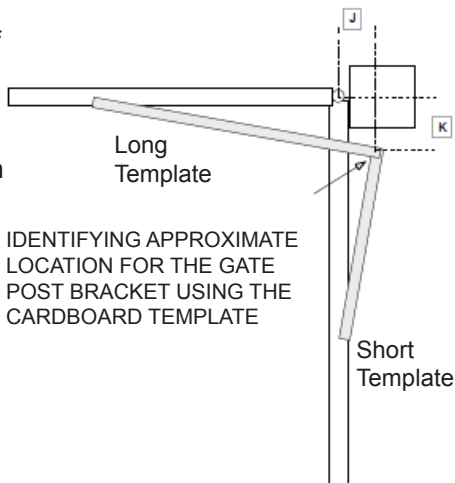

Pull-to-Open Setup How to use the cardboard template

Working out the positions of the gate bracket and post bracket and setting up your pivot point for the actuator arm

With the gate in the closed position place the template on the ground approximately where the pivot point of the arm is to be installed.

See page 22 for pivot point identification.
See page 25 for pivot point measurements.

Image A, shows the template setup with the LONG section where the gate is closed and the SHORT section where the gate will opens to.

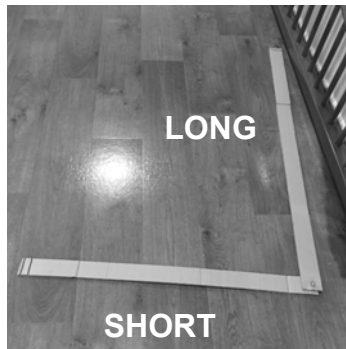

Image A

Pull-to-Open Setup

How to use the cardboard template

With your template in position, open the gate to where you want your gate to always open to (usually 90 degrees)

Now position the SHORT part of the template to where the gate is opened (image B) and mark the gate with a piece of tape between the 2 end lines on the template (image C). This will represent the gate bracket pin.

Now close the gate to hit it's stop and bring the LONG template to the gate (image D).

Check that the tape marked on the gate falls within the LONG cardboard template (image D). If it does, then you have the gate bracket marked and positioned on your gate as well as having positioned your actuator arm pivot point correctly, which will give you a solid push on your gate stop in the closed position.

If the tape falls outside the LONG cardboard template then your pivot point is not correct which will result in your gate not fully closing. Try adjusting your pivot point and start again.



Image B

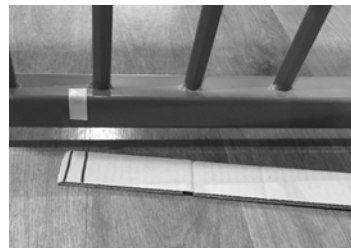

Image C



Image D

Pull-to-Open Setup

Installing Primary and Secondary post brackets

Now that you have your gate and post bracket points marked along with your arm pivot point, you can now go ahead and attach these brackets into position (clamp first if preferred).

Once you have secured the primary post bracket (or round post bracket) you can then slide the secondary bracket between the middle gap of the primary wall bracket. Do not tighten the nylon nut yet.

Note: these brackets should be checked on a regular basis.

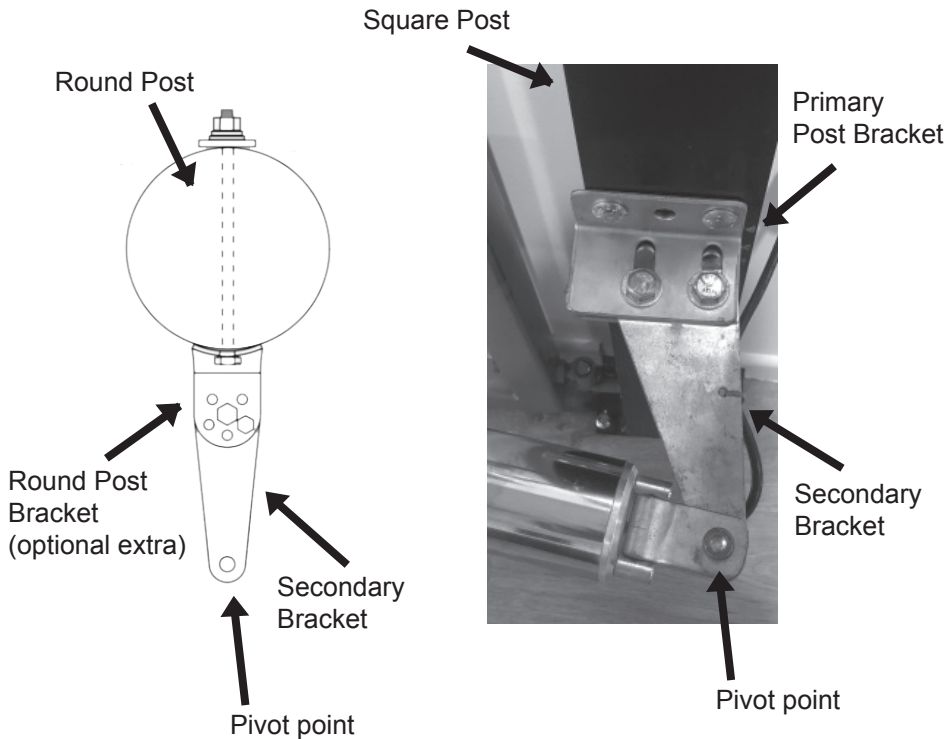

Note: Bracket modifications may be required due to your post and hinge setup. Contact your dealer if you require further assistance.

continued.....

Once you have setup your post bracket and secondary bracket, then secure the actuator arm to the secondary bracket with the bolt supplied. **DO NOT** overtighten this bolt.

With the gate in the open position and the arm fully retracted, attach the standard gate bracket to the actuator arm, see pg 24 (don't secure with bolt just yet) then swing the arm with the gate bracket to the position point on your gate (which should be close to your template marking).

If possible, clamp your gate bracket to the gate (ensure that the actuator arm is level). Now do a test run with the motor cables direct to a 12v battery (if you were supplied with a battery in your kit then use this, otherwise any 12v battery will do).

Attach the red cable to your positive terminal and blue cable to your negative terminal to extend the actuator arm till your gate is fully closed or max extension has been reached (which ever comes first).

If your gate fully closes with no binding (see binding image pg 26) on the rear cap and secondary bracket and your arm is not running parallel (refer to page 26) with the gate at any point (in the closed or open position) then you can go ahead and secure your gate bracket to the gate with the mounting bolts supplied.

If your setup doesn't comply with these checks then you will need to adjust your pivot point at the secondary bracket and repeat the above process.

Image A & B
incorrect setup



Image C correct setup
Secondary bracket must be used

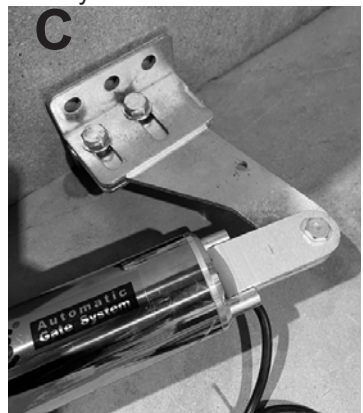

Pull-to-Open Setup

Actuator arm installed onto standard gate bracket or round gate bracket

Standard Gate Bracket
Supplied in kit

Round Gate Bracket
Optional extra

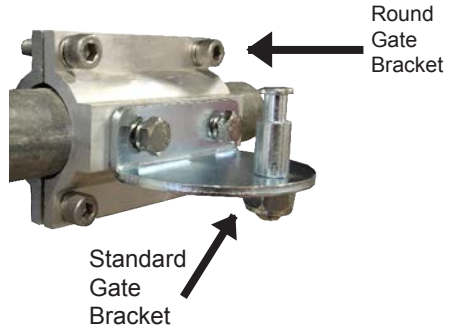
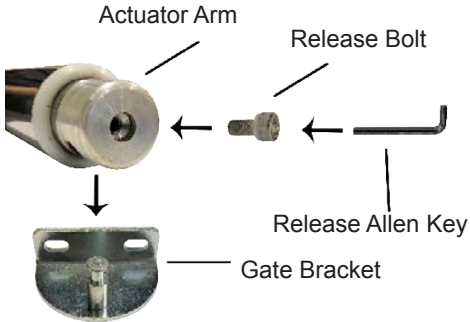

Attaching the actuator arm to the gate bracket

- Step 1.** Place the actuator arm onto the gate bracket pin
Step 2. Screw in the release bolt using the release allen key.

Round gate bracket setup example



How to clamp gate bracket

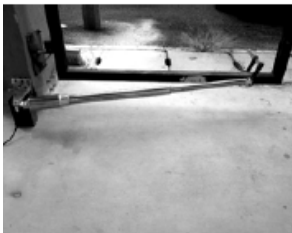

Pull-to-Open Setup

Checking the minimum clearance required between the actuator arm and gate if the J & K measurements listed on page 16 are unattainable



Image above shows the gate in the open position with the arm retracted and using the standard gate bracket and post brackets supplied in the kit.

Minimum clearances required between the gate and actuator arm are shown below with the gate in the open position and arm fully retracted - this is to prevent the gate opener from running parallel with the gate.

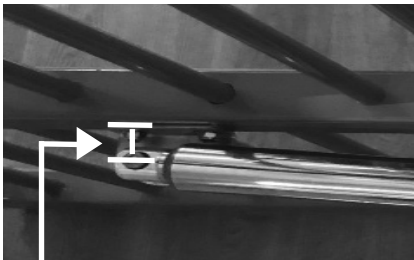

1. Minimum measurement required between centre pin and gate
Using standard gate bracket = 35mm
Using round gate bracket = 47mm



2. Minimum measurement required between centre back pin and gate
Using standard gate bracket = 110mm
Using round gate bracket = 122mm

Ensure there is sufficient angle so that the gate never runs parallel with the actuator arm in either the closed or open positions.

It is important that in both the full open and full close positions, the arms must not be parallel to the gate. A parallel arm will not result in a turning movement to the gate causing potential damage to both gate and actuator arm.

Pull-to-Open Setup

Now place gate in the closed position and check that the rear cap actuator pins do not bind on the secondary bracket (see image below).

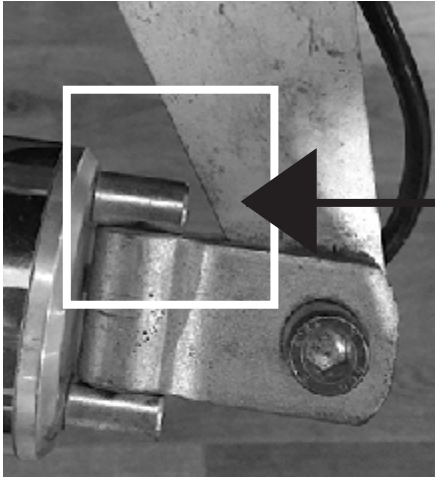

Rear cap actuator pins should NEVER bind onto the secondary bracket

VERY IMPORTANT

THE 2 PHOTOS BELOW ARE SHOWING AN INCORRECT SETUP WITH THE ARM RUNNING PARALLEL

THIS WILL CAUSE YOUR GATE TO **NOT** FUNCTION CORRECTLY



Push-to-Open Setup

Identifying Primary post bracket position

There are 2 possible mounting positions for the post bracket for push to open gates.

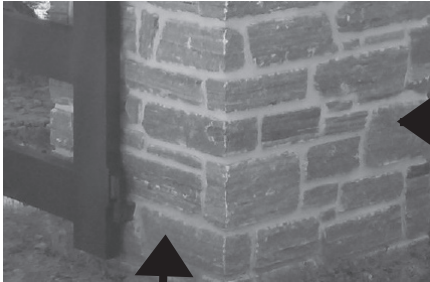

Option B
Inside face mounting



Option A
Rear post mounting



Push-to-Open Setup - TEMPLATE

You may require the longer push to open secondary bracket for this setup (see optional extras page 9)

You will be supplied with a cardboard template in your kit. The long section of the template represents the actuator arm at full extension and the short section of the template represents the actuator arm retracted. The lines on the end of the template represents the gate bracket pin.

Identifying approx. location for the gate post bracket pivot point using the cardboard template

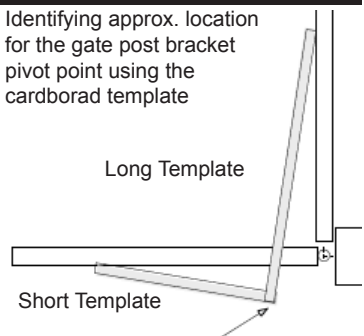

Push-to-Open Setup

How to use the cardboard template

Working out the positions of the gate bracket and post bracket and setting up your pivot point for the actuator arm.

Position the template on the ground approximately where the pivot point of the arm is to be installed.

See page 29 for pivot point identification.
See page 33 for pivot point measurements.

Open the gate to where you want your gate to always open to (usually 90 degrees).

Now position the LONG part of the template to where the gate is opened (image A) and mark the gate with a piece of tape between the 2 end lines on the template (image B). This will represent the gate bracket pin.

Now close the gate to hit it's stop and bring the SHORT template to the gate (image C).

Check that the tape marked on the gate falls outside the short cardboard template (image D). If it does, then you have the gate bracket marked and positioned on your gate as well as having positioned your actuator arm pivot point correctly, which will give you a solid push on your gate stop in the closed position.

If the tape falls within the short cardboard template then your pivot point is not correct which will result in your gate not fully closing. Try adjusting your pivot point and start again.

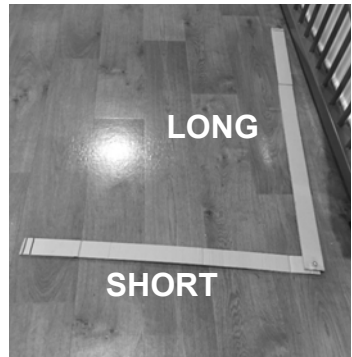

Image A

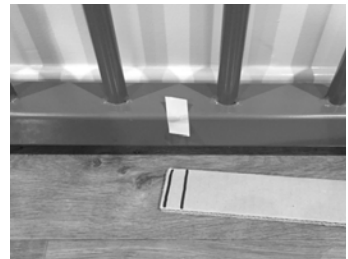

Image B



Image C

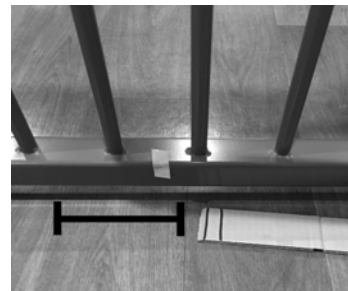

Image D

Installing Primary and Secondary post brackets

Now that you have your gate and post bracket points marked along with your arm pivot point, you can now go ahead and attach these brackets into position (clamp first if preferred).

Once you have secured the primary post bracket (or round post bracket) you can then slide the secondary bracket between the middle gap of the primary wall bracket. Do not tighten the nylon nut yet.

Note: these brackets should be checked on a regular basis.

Option A

Rear post mounting

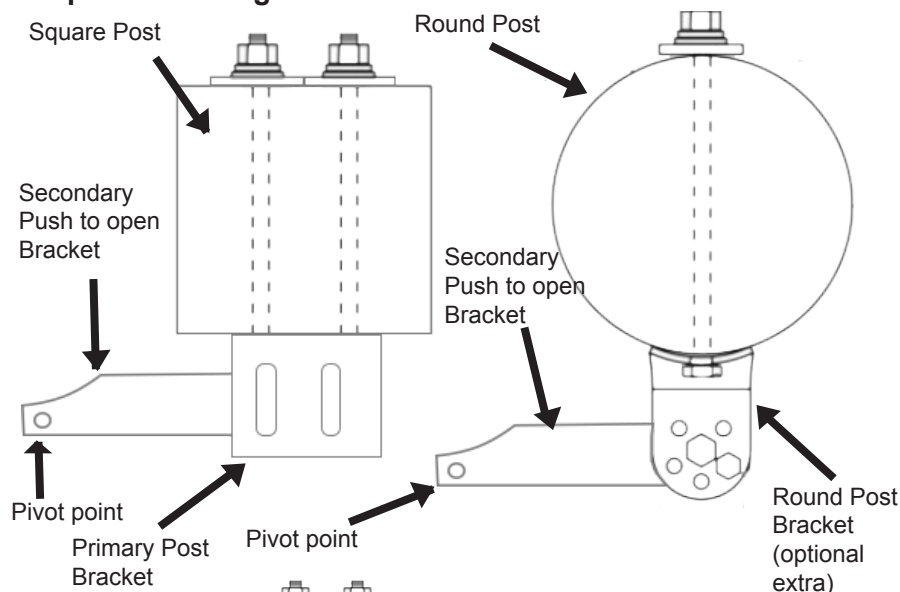

Option B

Inside face mounting

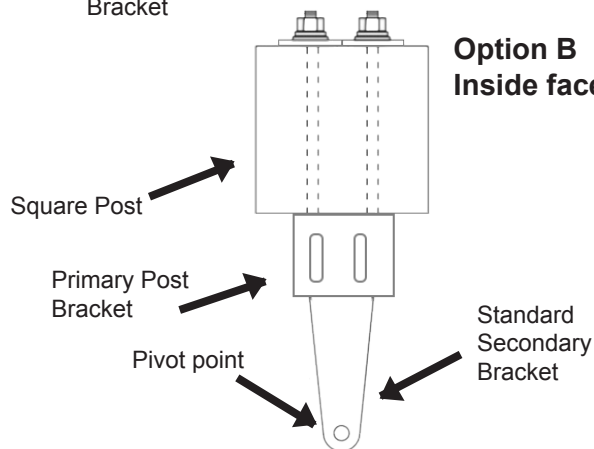

Note: Bracket/mounting points may need to be modified from the standard instructions due to your post and hinge setup. Contact your dealer if you require further assistance.

Continued.....

Once you have setup your post bracket and secondary bracket, then secure the actuator arm to the secondary bracket with the bolt supplied. DO NOT overtighten this bolt.

With the gate in the open position and the arm fully extended (extend the arm by either manually turning the rod anti clockwise or place the arm cables direct to the battery - red cable to positive and the blue cable to negative), now attach the standard gate bracket to the actuator arm (don't secure with bolt just yet) then swing the arm with the gate bracket to the position point on your gate (which should be close to your template marking).

If possible, clamp your gate bracket to the gate, see pg.31 (ensure that the actuator arm is level). Now do a test run with the motor cables direct to a 12v battery (if you were supplied with a battery in your kit then use this, otherwise any 12v battery will do).

Attach the red cable to your negative terminal and blue cable to your positive terminal to retract the actuator arm till your gate is fully closed or max retraction has been reached (which ever comes first).

If your gate fully closes with no binding (see binding image pg 34) on the rear cap and secondary bracket and your arm is not running parallel (refer to page 31 - 32) with the gate at any point (open or closed) then you can go ahead and secure your gate bracket to the gate with the mounting bolts supplied.

If your setup doesn't comply with these checks then you will need to adjust your pivot point at the secondary bracket and repeat the above process.

Image A & B
incorrect setup

Image C correct setup
Secondary bracket must be used

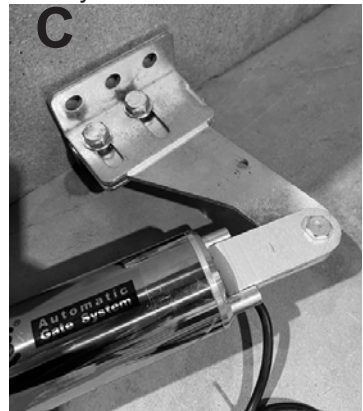

Push-to-Open Setup

Actuator arm installed onto standard gate bracket or round gate bracket

Standard Gate Bracket
Supplied in kit

Round Gate Bracket
Optional extra

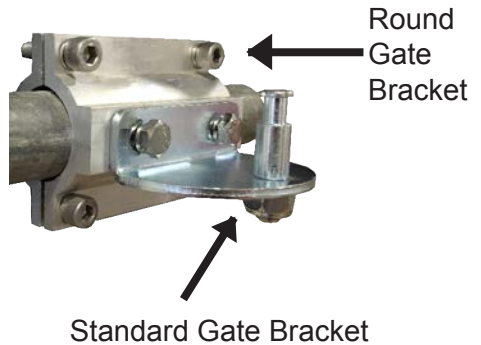
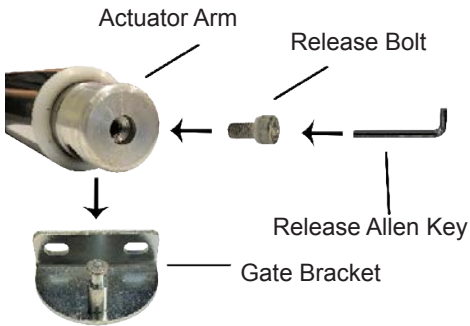

Attaching the actuator arm to the gate bracket

- Step 1.** Place the actuator arm onto the gate bracket pin
- Step 2.** Screw in the release bolt using the release allen key.

Round gate bracket setup example



How to clamp the gate bracket



Push-to-Open Setup

Checking the minimum clearance required between the actuator arm and gate

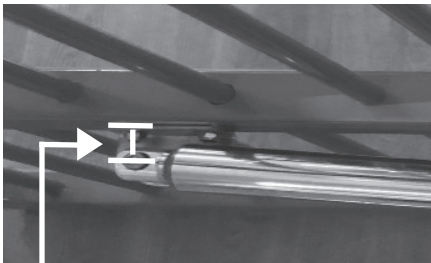

Image above showing rear mounted post bracket with the gate in the open position



Image above showing rear mounted post bracket with the gate in the closed position

Minimum clearances required between the gate and actuator arm are shown below - this is to prevent the gate opener from running parallel with the gate.



1. Minimum measurement required between centre pin and gate
Gate in closed or open position with arm retracted should be no less than
Using standard gate bracket = 35mm
Using round gate bracket = 47mm



2. Minimum measurement required between centre back pin and gate
Gate in closed or open position with arm retracted should be no less than
Using standard gate bracket = 110mm
Using round gate bracket = 122mm

Push-to-Open Setup

Ensure there is sufficient angle so that the gate never runs parallel with the actuator arm in either the closed or open positions.

It is important that in both the full open and full close positions, the arms must not be parallel to the gate. A parallel arm will not result in a turning movement to the gate causing potential damage to both gate and actuator arm.



THESE 3 PHOTOS
ARE SHOWING AN
INCORRECT
SETUP WITH
THE ARM
RUNNING
PARALLEL

THIS WILL CAUSE
YOUR GATE TO NOT
FUNCTION
CORRECTLY

THIS PHOTO
SHOWS THE
ANGLE REQUIRED
WHEN THE GATE
IS FULLY OPENED
AND CLOSED

Now place gate in the open position and check that the rear actuator cap pins do not bind on the secondary bracket (see image below).

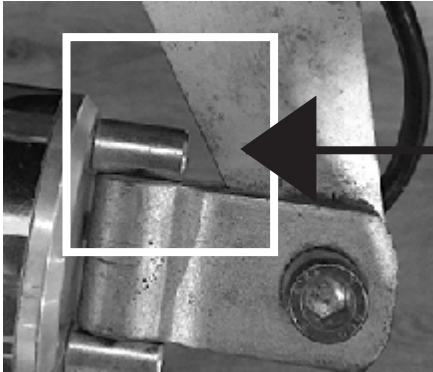

Rear actuator cap pins should NEVER bind onto the secondary bracket

Transformer Wiring Installation

The Transformer can be relocated up to 50mtrs from the control box. You **MUST** install the transformer via a RCD to avoid injury from shock as per local government electrical requirements. Always switch off mains power when any work is being carried out on or around the gate installation. Always ensure that the transformer is properly protected from water and dampness. We recommend a minimum 2.5mm x 2 core cable. Connect the male plug of the transformer into the 240Vac power socket and connect the output cable (16Vac) into the EGA-04 control board.

Transformer



**TRANSFORMER MUST PLUG INTO A
240VAC POWERPOINT
DO NOT HARDWIRE
OR THIS WILL VOID WARRANTY**

Refer to the separate coloured
“Wiring Guide” for a step-by-step way
to install the control box

Solar Wiring Installation

Connection of Power Source (Solar)

The system can be solar powered via an optional solar system with 12V voltage regulator connected directly to the battery.

Do NOT use both solar and mains power at the same time.

The Solar panel must face FULL NORTH with the recommended tilt and within 10m of the battery. The panel requires a minimum of 6 hours of direct sun light to be effective (hand print size shading will reduce output by up to 80%). The Regulator is not weatherproof and must be located inside the control box to protect it.

Additional accessories connected may reduce the batteries performance e.g battery life and/or battery standby capacity during unfavourable conditions.

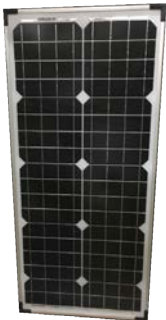

Refer to the separate coloured “**Wiring Guide**” for a step-by-step way to install the components in the control box

45 watt Solar Panel wire colour coding:
RED wire is Positive (+)
BLACK wire is Negative (-)

The solar panel is supplied with 10mtrs of cable. You can extend the cable another 20mtrs to get the panel into the required 6hrs of full sunlight a day.

INCORRECT



Solar panel should be installed with junction box at the top
Best solar panel angles below for all year round panel must face FULL NORTH

- Brisbane 38°
- Sydney 45°
- Melbourne 50°
- Tasmania 56°
- Adelaide 48°
- Darwin 14°
- Perth 43°

0° being flat and 90° vertical

CORRECT



Setting Up Your Control Board

After installing the actuator arm/s and completing the wiring as shown in the coloured wiring manual for your gate opener kit, have the gate/s in the open position.

If your unit is an ELECTRIC kit with a TRANSFORMER, turn your transformer on now. The control board will make a “BEEP” sound and then run through a start-up sequence which you will see on the digital display labelled MENU. Wait 10 seconds for the control board to finalise this step.

If your unit is a SOLAR POWERED kit, connect the SOLAR PANEL to your regulator and connect the battery up to the power cables. The control board will make a “BEEP” sound and then run through a start-up sequence which you will see on the digital display labelled MENU. Wait 10 seconds for the control board to finalise this step.

If your control board came to you with a complete gate kit, your remotes will already be tuned in.

For a dual swing gate, your remote buttons will be:

- Button A Controls Dual gate open / close
- Button B Spare button, not in use.
- Button C Party mode, this feature overrides auto close.
*Auto close is turned off, you will need to turn this on yourself if you would like this feature.
Refer to Menu settings to set this up.
- Button D Spare button, not in use.

For a single swing gate, your remote buttons will be:

- Button A Controls Single (Main Motor) gate open / close
- Button B Spare button, not in use.
- Button C Party mode, this feature overrides auto close.
*Auto close is turned off, you will need to turn this on yourself if you would like this feature.
Refer to Menu settings to set this up.
- Button D Spare button, not in use.

BEFORE LEARNING, ENSURE NO ACCESSORIES HAVE BEEN CONNECTED TO THE GATE OR THE CONTROL BOARD, SUCH AS ELECTRIC GATE LOCKS, HARD WIRED KEYPADS, SAFETY SENSORS ETC. AS THIS MAY INTERRUPT THE LEARNING PROCESS.

Auto Travel Function

IMPORTANT - Dual swing AUTO TRAVEL procedure:



SCAN ME

ENSURE THE GATE WAY ENTRANCE IS CLEAR OR ANY OBSTRUCTIONS.

To perform the 'AUTO TRAVEL' function, you will need to activate your gate opener with a remote. Press Remote Button (or the remote you are using for this system) for 2 seconds or until the small LED light on the remote flickers, now release your remote button. You should observe "OP" appearing on the Digital Display "MENU".

For a dual swing gate, the display "MENU" will show OP to say the control board has put Motor 1 gate into an OPEN position, the "MENU" will then show SP to say the control board has turned Motor 1 off. The display "MENU" will repeat this sequence for Motor 2.

With the control board now knowing your gates are in the open position, you will need to press the DEC and INC buttons at the same time for 5 seconds or until one gate starts to close, now release INC and DEC buttons (you must press and hold in both buttons at the same time for this to work, pressing the buttons individually first will not allow the control board to run its 'AUTO TRAVEL' function).

The gate connected to Motor 1 will close first, the "MENU" will display CL (Close), after Motor 1 has closed the gate, the "MENU" will display SP (Stop). Motor 2 will now close with the "MENU" displaying CL (Close), after Motor 2 has closed the gate, the "MENU" will display SP (Stop).

1 second after Motor 2 has closed the gate it will activate again with the "MENU" displaying OP (Open), after Motor 2 has opened the gate, the "MENU" will display SP (Stop). Motor 1 will now open the gate with the "MENU" displaying OP (Open), once the gate is open the "MENU" will display SP (Stop). Wait 10 seconds before operating the gate opener. Travel function completed.

Press the remote trigger button on your remote for 2 seconds or until the LED light starts to flicker and then release the button.

Check that your gates operate correctly. Check if your force settings need to be adjusted. If they require adjusting, please refer to the MENU settings to adjust P1 through to P4 as well as P5 and P6.

Auto Travel Function

IMPORTANT - Single swing AUTO TRAVEL procedure:

ENSURE THE GATE WAY ENTRANCE IS CLEAR OR ANY OBSTRUCTIONS.



SCAN ME

To perform the 'AUTO TRAVEL' function, you will need to activate your gate opener with a remote. Press Remote Button (or the remote you are using for this system) for 2 seconds or until the small LED light on the remote flickers, now release your remote button. You should observe "OP" appearing on the Digital Display "MENU".

For a Single swing gate, the display "MENU" will show OP to say the control board has put Motor 2 gate into an OPEN position, the "MENU" will then show SP to say the control board has turned Motor 2 off.

With the control board now knowing your gate is in the open position, you will need to press the DEC and INC buttons at the same time for 5 seconds or until one gate starts to close, now release INC and DEC buttons (you must press and hold in both buttons at the same time for this to work, pressing the buttons individually first will not allow the control board to run its 'AUTO TRAVEL' function).

The gate Motor 2 will now close with the display "MENU" displaying CL (Close), after Motor 2 has closed the gate, the "MENU" will display SP (Stop). 1 second after Motor 2 has closed the gate it will activate again with the "MENU" displaying OP (Open), after Motor 2 has opened the gate, the "MENU" will display SP (Stop). Wait 10 seconds before operating the gate opener. Travel function now completed.

Press remote trigger button on your remote for 2 seconds or until the LED light starts to flicker, then release the button.

Check that your gate operates correctly. Check if your force settings need to be adjusted.

If they require adjusting, please refer to the MENU settings to adjust P3, P4 and P6.

Majority of gates won't require any adjustments.

Remotes

Remote Learning - compatible remotes with A, B, C, D buttons (orange LED light)

To learn new remotes to your control board.

Press the Learn button for 1 second and then release. The STATE red LED light will go out. Now press button A on your remote once for 2 seconds or until LED light begins to flash, the control board will “BEEP” once and display the remote number you just learnt.

Remote 1 will show 01, remote 5 will show 05 etc.

The STATE red LED light will come back on solid.

Your remote is now tuned in.

Button A and C will automatically be assigned functions.

These functions cannot be altered or removed.

Button A	Full open / close for Dual swing gates and Single swing gates
Button B	Empty
Button C	Party mode function. Party mode is used to override auto close. It will override P9 auto close function. You must be within 1 metre of the gate to ensure you are within working range for the remote.
Button D	Empty

Button C Party mode, this feature overrides auto close.

Auto close is turned off when you receive the kit, you will need to turn this on yourself if you would like this feature. Refer to Menu settings to set this up.

To disable auto close, press button A on your remote to open your gate, once the gate has reached the full open position, wait 2 seconds, now press button C on your remote for 2 seconds or until the orange LED light comes on for your remote.

You should be within 1 metre of the control box when activating this function to ensure the signal has been picked up by the control board.

Now wait for the auto close time to pass to ensure you have successfully bypassed the auto close function.

When you are ready to close the gate, press Button A on you remote or any triggering devices you might have e.g. push button or keypad. Your auto close function will be reactivated for the next time the gate is opened.



Erasing Remotes

Press and hold the Learn button for 8 seconds, the buzzer will beep and the digital display will read 00. At this time, all the information stored in the on board receiver has been deleted, release the Learn button.

Remote distance – up to 30mtrs. This distance will vary greatly due to site interference that may not be visible to the eye. Some sites will allow for greater range than 30mtrs, some sites might only achieve 5mtrs.

Remote frequency – Rolling code 433mhz

*Only genuine remotes will operate with the on board receiver. To ensure your remote is a genuine remote, you will notice the small LED light will flicker an ORANGE colour when you press one of the 4 buttons on your remote for 2 seconds or until the light starts to flicker.

Remote Storage – The on board receiver can store up to 120 remotes.

Menu Settings

To enter the Menu settings, the gate/s must be in either the full Open or full Close position, the control board will not allow you to enter the Menu settings while the gate opener is operating.

Press and hold “FUN” button for 2 seconds or until the Digital Display shows P0. From here use “DEC” or “INC” buttons to go down or up the menu list, once you are on the menu setting you need, press “FUN” button once to enter the setting. Now use “DEC” or “INC” to decrease or increase the parameter number, once you have selected the parameter number you require, press the “FUN” button to confirm the new setting.

To exit the menu setting, press the “Learn” button once.

Now test your adjusted settings.

Menu	Main Feature	Parameter	Parameter Feature	Detailed Description	
P0	Activates Single swing or Dual Swing mode	0	Double Swing gate	BMG will have the system set to match your unit when purchased with a gate opener kit.	
		1	Single Swing gate (Default setting)		
P1	Motor 1 open gate obstacle sensitivity	1	1 (Most Sensitive)	Adjust from 1 to 12, the higher the number, the greater force required to stop the gate. For heavy gates or long gates, you may need to adjust this setting to a higher number. The lower the number the easier it is to stop the gate. For light weight gates or short gates, you may need to adjust this setting to a lower number.	
		...	Factory set 7		
		12	12 (Less Sensitive)		
P2	Motor 1 close gate obstacle sensitivity	1	1 (Most Sensitive)		
		...	Factory set 7		
		12	12 (Less Sensitive)		
P3	Motor 2 open gate obstacle sensitivity	1	1 (Most Sensitive)		The current of the motor running in the 12V system is relatively large, it is recommended to set the value between 5-12 levels.
		...	Factory set 7		
		12	12 (Less Sensitive)		
P4	Motor 2 close gate obstacle sensitivity	1	1 (Most Sensitive)		
		...	Factory set 7		
		12	12 (Less Sensitive)		

Menu	Main Feature	Parameter	Parameter Feature	Detailed Description
P5	Motor 1 low speed obstruction sensitivity	1	1 (Most Sensitive)	Soft stop force adjustment
		...	Factory set 8	
		12	12 (slowest)	
P6	Motor 2 low speed obstruction sensitivity	1	1 (Most Sensitive)	Soft stop force adjustment
		...	Factory set 8	
		12	12 (slowest)	
P7	Slow speed running time	0	No slow speed	This adjusts the ramp down of the gate. The slow speed can be adjusted (0 not recommended as this puts extra stress on moving parts). For long gates we recommend the standard setting of 2.
		1	Shortest	
		...		
		5	Longest	
P8	Closing delay time	0	No delay	This setting is for Dual Swing gates. You can adjust the closing delay between the two motors. This is required if you have an electric gate lock connected to the control board or if you require Motor 1 to close first. You can set this from 0 seconds (open and close at the same time) up to 8 seconds. Factory setting is 2 seconds and is recommended even if a gate lock is not installed.
		1	1s	
		2	Factory Set 2s	
		...		
		8	8s	
P9	Main Auto Closing	0	Factory Set	Auto close setting can be set from 0 seconds (factory setting) up to 99 seconds.
		1	1s	
		
		99	99s	
PA	Electric lock output mode	0	Not output (factory set)	This setting allows you to adjust the output to your optional electric gate lock. Factory setting is 0 which is set for NO GATE LOCK. If you install a gate lock, it is recommended you set PA to level 3 (3 seconds). This may need to be adjusted depending on your gate setup. If lock output is set 1 to 6, the lock will activate first for 1 second before the gate starts, this is to allow time for the lock to activate.
		1	1s	
		
		6	6s	

Menu	Main Feature	Parameter	Parameter Feature	Detailed Description
PB	Lamp output mode	1	Mode 1 (factory set)	Set lamp work mode by menu PB , factory set mode 1 1: Lamp output on when motor operating, when motor stops lamp turns off 2: Lamp output flash when motor operating, when motor stops lamp turns off 3: Lamp output on when motor operating, after motor turns off 30 seconds later the lamp output turns off 4: Lamp output flashing when motor operating, after motor turns off 30 seconds later the lamp output turns off
		2	Mode 2	
		3	Mode 3	
		4	Mode 4	
PC	Electric lock auxiliary function	0	Open (factory set)	Factory setting Motor 2 will activate after 1 second to allow gate lock to release. Setting PC to 1 will make Motor 2 reverse (Close) for 0.5 seconds to help release pressure off the lock before allowing Motor 2 to activate.
		1	Close Reverse first	
PD	Infrared terminal set	0	NO mode (factory set)	If you run safety beams, you will need to set PD to 1. Factory setting allows you to operate without safety beams.
		1	NC mode	
PE	Soft start time	1	1s (factory set)	You can adjust the soft start time of your gate. This may need to be adjusted for longer gates and heavy gates
		2	2s	
		3	3s	
PF	Remote control mode	0	One Gate Mode	If you have 2 gate opener kits on the one property and are within 100 metres of each other, your control board will be set to 01. This will have your remote set to: Gate 1 Button A – Full open/close Button C – Party mode Gate 2 Button B – Full open/close Button D – Party mode Factory set mode 01
		1	Two Gates Mode (factory set)	
PP	System set	00	Nothing	This setting will put your control board back to factory settings and put your unit to Single swing gate. This would then need to be adjusted to suit a double swing gate.
		
		05	Factory reset	
		
		09	Nothing	

Control Board Specifications and Details

Power Supply

Power Supply	AC12 V – AC16 V
Fuse	10A
External Accessory Power Supply	No more than 300mA
Alarm Light Power Supply	No more than 500mA
Electric Lock Power Supply	No more than 2.5A

The EGA control board has been specifically designed for this kit and SHOULD NOT be used for any other setup

CONTROL BOARD

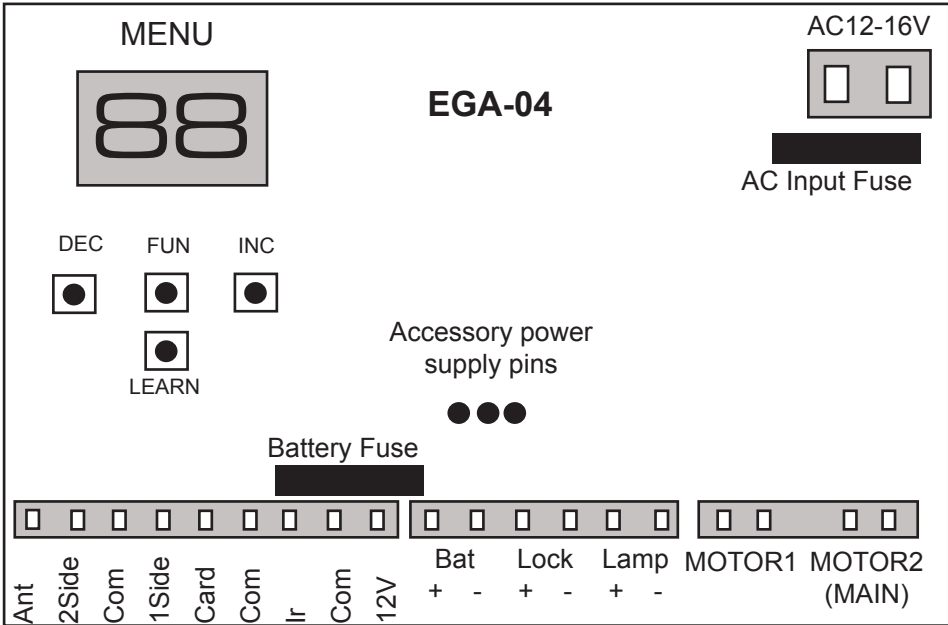

Tip: Green connector blocks on the main control board can be removed to help with wiring in cables

Control Board Specifications and Details

Control Board

Ant	Antenna for control board
2Side	Terminal for external device of controlling double gates
Com	Common for external device
1Side	Terminal for external device of controlling single gate (Motor2)
Card	Terminal for external device for OPEN ONLY trigger (set P9 auto close)
Com	Common for external device
IR	Terminal for Photo beam sensor
Com	Common for Photo beam sensor
12V+	Power supply for external device
Bat	Terminal for 12V Battery
Lamp	Terminal for lamp
Lock	Terminal for lock
Accessory pins	Allows power through to the accessory terminals * Placing the jumper on the left 2 pins provides power from the transformer * Placing the jumper on the right 2 pins provides power from the battery

Instructions for Indicator

State Indicator	Steady on: Indicating that the system is working normally Blinking at 1Hz: indicating that the system is in the mode of auto close or travel learning. Fast blinking: The system is error.
Terminal Indicator	On: The terminal is ON. Off: The terminal is OFF

Instructions for button

DEC	used for lowering values
FUNC	used for entering the menu and storing the settings
INC	used for increasing values
RF Learn	used for learning or removing remotes

Other Considerations

Gate Stop must be installed in the centre of the driveway for double gates to close up onto and apply solid pressure.

Arm Condensation Drain Hole: Always mount arms with condensation drain holes facing down or water will enter the motor and damage the electrics voiding the warranty.

This is indicated on your arm with the **“THIS SIDE DOWN”** marking.

Actuator Arms must not be parallel with the gate but must be level with the gate.

Wiring Double Gates:

Connect your arms to [MOTOR1] and [MOTOR2(MAIN)].

We recommend using .66mm wire or greater. Lighter cable will restrict the performance of the system. Use a suitable electrical junction box to protect cable joints from moisture damage.

Please note:

Motor forward and reverse judgement: when the motor is running, the LED display should show OP, the gate must be in its opening state, when the LED display shows CL, the gate must be in its closing state.

Only when the motor power cable is correctly connected, the system can function normally.

Safety Feature

Rebound function: If the gate is encountering resistance in high speed running period, the gate will stop and then rebound.

Limit function: If the gate is encountering resistance in the end position, the motor will automatically stop running to achieve the limit.

Stall force can be adjusted through P1 to P4.

Troubleshooting

Problem: The gate does not travel smoothly when opening or closing.

Solution:

- Ensure there is no obstruction to the movement of the gate such as hitting the ground. This can be verified by releasing the gate to emergency release mode. Manually swing the gate open/close to detect any tight spots.
- Ensure that the gate is properly leveled and that the dimension guide for the installation of the automatic gate is followed.
- Actuator arms **must not be** parallel to the gate when fully open or fully closed.

Problem: The system does not respond when the remote is pressed.

Solution:

- Make sure the remote is in good condition. Ensure that the battery is functioning and the LED on the remote lights up when the button is pressed. Replace the battery if the remote only works at very close range to the receiver.
- Try tuning remote back into onboard receiver in case it has dropped out.
- Try other optional activation devices such as the exit button or keypad. This will insure that the issue is with the remote receiver and not the actual main board.
- Check the arms are working using the power directly from the battery. Cables on the battery one way will retract the arm, and the opposite way will extend the arm.
- Check wires are connected properly to the control board. Ensure there are no exposed cables that could cross over and short the main board.
- If the system is Solar Powered, charge the battery on low voltage battery charger for 2 hours (even if charger indicates the battery is charged, still charge for 2 hours).
- If the system is Electric and you have a backup battery, try running the kit off the transformer only (backup battery may have died and drawing down on the transformer power). If the kit doesn't run on the transformer then try the battery only (providing it hasn't died or that it still has power).
- Check fuses for either solar setup or electric.

Problem: The gate does not fully open and close, or stops half way.

Solution:

- Ensure there is no obstruction to the movement of the gate. This could also be high resistance such as poor gate installation or high winds activating the anti obstruction sensing. This can be verified by releasing the gate to the emergency release mode (remove the arms from the gate). Manually push the gate open and close to detect any obstruction.
- Ensure that on the first setup, the gate is fully closed or opened before the board is initialised. Short distance detection will result in error of count for the total time of the gate swing. Try turning the forces up in your menu settings.
- Ensure that when the arm actuators are removed from the gate, the gate does not have a tendency to swing open or close but stays stationary. Self opening or closing gates will cause an uneven force for opening and closing.
- If the system is Solar Powered, charge the battery on a car battery charger for 2 hours (even if charger indicates the battery is charged) still charge for 2 hours.

Usage Problems

Fault	Reason and Solutions
1. Motor running and suddenly stops	<p>Obstacle sensitivity may be set too low and as the motor starts running its current value is higher than the obstacle sensitivity, this will cause the motor to stop.</p> <p>Solution: Adjust the sensitivity value</p>
2. Auto travel learning fail	<p>1. When the motor is in its auto travel learning process and the infrared / remote / terminal signal triggers learning fail</p> <p>Solution: Don't trigger infrared / remote/ terminal signal when the motor is in auto travel learning</p> <p>2. Auto travel learning time is too short</p> <p>Solution: The control boards single direction work time request must be more than 5s, if it's not then auto travel learning will fail</p>

Attaching Control Box Lid

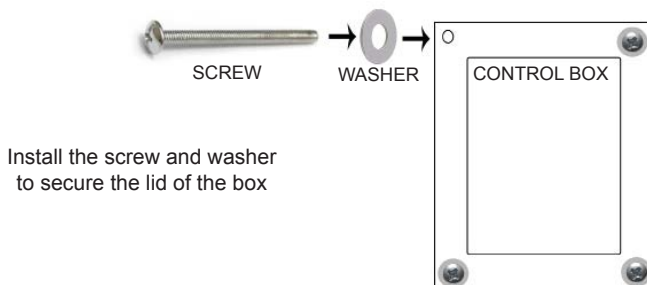

Other Information

Important Notice

An auto gate system cannot prevent burglary. It is only a replacement way for the user to open the gate. Auto gate systems are generally very reliable but they may not work under all conditions and they are not a substitute for prudent security practices or life and property insurance. Your auto gate system should be installed and serviced by qualified professionals who should instruct you on the level of protection that has been provided and on the system operations.

Note to Installers

This warning contains vital information. As the only individual in contact with the systems user, it is your responsibility to bring each item in this warning to the attention of the users of this system.

Systems Failures

This system has been carefully designed to be as effective as possible. There are circumstances, however, involving fire, burglary, or other types of emergencies where it may not provide protection. Any auto gate system of any type may be compromised deliberately or may fail to operate as expected for a variety of reasons. Some but not all of these reasons may be:

Inadequate Installation:

A security system must be installed properly in order to provide adequate protection. Every installation should be evaluated by a security professional to ensure that everything is correct.

Criminal knowledge:

This system contains security features which were known to be effective at the time of manufacture. It is possible for persons with criminal intent to develop techniques which reduce the effectiveness of these features. It is important that an auto gate system be reviewed periodically to ensure that its features remain effective and that it be upgrade or replaced if it is found that it does not provide the protection expected.

Power Failure:

Control units require an adequate power supply for proper operation. If a device operates from batteries, it is possible for the batteries to fail. Even if the batteries have not failed, they must be charged, in good condition and installed correctly. If a device operates only by AC power, any interruption, however brief, will render that device inoperative while it does not have power. Power interruptions of any length are often accompanied by voltage fluctuations which may damage electronic equipment such as security system. After a power interruption has occurred, immediately conduct a complete system test to ensure that the system operates as intended.

Failure of Replaceable Batteries:

The expected battery life is a function of the device environment, usage a type. Ambient conditions such as high humidity, high or low temperatures, or large temperature fluctuations may reduce the expected battery life. A low battery will casue a low power condition in the system which will then have a problem functioning as usual. Regular testing and maintenance will keep the system in good operating condition.

Compromise of Radio Frequency (Wireless) Devices:

Signals may not reach the receiver under all circumstances which would include metal objects placed on or near the radio path or deliberate jamming or other inadvertent radio signal interference.

Component Failure:

Although every effort has been made to make this system as reliable as possible, the system may fail to function as intended due to the failure of a component.

Inadequate Testing:

Most problems that would prevent an auto gate system from operating as intended can be found by regular testing and maintenance. The complete system should be tested weekly and immediately after a break-in, an attempted break-in, fire, storm, earthquake, accident, or any kind of construction activity inside or outside the premises.

PLEASE VISIT OUR WEBSITE FOR TERMS AND CONDITIONS WWW.BMGI.COM.AU

Routine Maintenance

Every 6 - 12 months

1. Check gate over to ensure gate is still in good working order – Refer to page 13 of user manual
2. If solar, using a multimeter, disconnect the solar panel from the solar regulator, now put your multimeter into reading 20vdc. While the battery is connected to the unit, place the multimeter pins onto the battery terminals and operate the gate for 3 complete cycles. Ensure the voltage remains above 12vdc. If your battery falls below 12vdc you should place it on a 12v battery charger and repeat this step once your charger says the battery is full. If the battery voltage drops below 12vdc, replace your battery.
3. Check that mounting brackets have not shifted and that bolts are tightened.
4. Check the actuator arm isn't binding on the secondary bracket at any stage – Refer to page 25 of user manual.
5. Check the actuator arm cable is still in good condition and no twists or kinks etc.
6. Check inside main control box to ensure no insects or moisture has gotten in
7. Check silicone is still in place of all entry points to the main control box and has not deteriorated over time
8. Check over all accessories that are connected to your automation kit such as keypads, push buttons, receivers etc.
9. If your unit is electric with backup battery, using a multimeter, turn off transformer power, now put your multimeter into reading 20vdc. While the battery is connected to the unit, place the multimeter pins onto the battery terminals and operate the gate for 3 complete cycles. Ensure the voltage remains above 12vdc. If your battery falls below 12vdc you should place it on a 12v battery charger and repeat this step once your charger says the battery is full. If the battery voltage drops below 12vdc, replace your battery.

Installer & Owner Notes

Tip: Green connector blocks on the main control board can be removed to help with wiring in cables